

SIRIUS Monitoring and Controlling: Overview of safety relays



safety

INTEGRATED



SIEMENS

Simpler, faster and more cost-effective to implement **a seamless safety chain**

Today, one of the key success factors is for machines and plants achieve the highest possible productivity. Standardized automation is playing a decisive role in achieving this goal as a result of the higher degree of flexibility and openness. Now if safety technology would follow this trend, your automation processes would become even more efficient. Siemens can offer you the optimum solution with our extensive safety portfolio – Safety Integrated: This safety system can be seamlessly integrated into standardized automation therefore creating the ability for machines and plants to operate more cost effectively. And it doesn't matter if it's a new design or a retrofit. SIRIUS® safety relays are an essential component in our seamless safety system portfolio. Practice-oriented and user-friendly, they meet all specified safety technology requirements and offer numerous additional advantages.

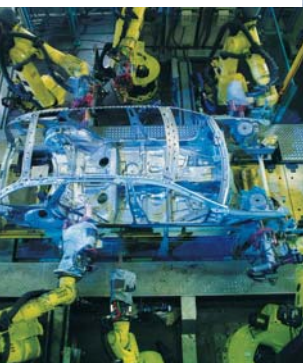

The seamless safety portfolio: Safety Integrated

More than 20 years of experience safety research and technology is reflected in our extensive Safety Integrated product portfolio. Whether for production or process industries – our program includes all elements essential for a seamless safety chain: From sensors through the evaluation equipment and up to safe shutdown. Today, this means that we are the only supplier that offers total solutions in the areas of detecting, evaluating and shutdown. All Safety Integrated products and systems are based on standard components, custom tailored for the world of Totally Integrated Automation®, and can be seamlessly integrated into your standard automation environment. This means that we can solve any safety application – simple or complex – quickly and cost-effectively.

Our SIRIUS Safety Integrated industrial controls are the specialists when it comes to seamless, integrated safety tasks on small or large scales. Whether for fail-safe detecting, commanding and signaling, monitoring and evaluating or starting and safe shutdown – our complete product range masters every challenge. This is true for basic up to more complex tasks that can be solved using standard fieldbus systems such as AS-Interface and PROFIBUS.

Experts for each and every case: SIRIUS safety relays

SIRIUS safety relays are the essential elements of an integrated, seamless and cost-effective safety chain. Whether involving EMERGENCY STOP shutdown, protective door monitoring or the optimum protection of presses or punches – our extensive range extends from cost-effective standard devices up to innovative, multi-function devices, all with an extremely high degree of flexibility. This is why we can really offer you a seamless portfolio that can tackle almost any application.

Our product set combines well-proven technology with innovative components and a high degree of functionality. The philosophy is clear: A maximum degree of safety with a maximum degree of cost-effectiveness. For example: Integrated diagnostics functionality and monitoring systems allow faults to be quickly detected, reduce undesirable downtimes and ensure a higher degree of availability for your machines and plants. In summary: Using SIRIUS safety relays not only reliably configures the complete safety chain but it does so quickly, simply and cost effectively.

SIRIUS safety relays: High performance across the board

- Using well-proven relay technology with positively driven contacts up to Category 4 according to EN 954-1.
- With redundant and diverse safety electronics up to Category 4 according to EN 954-1 and SIL 3 (Safety Integrity Level) according to IEC 61508
- With safety electronics and integrated contactor relays
- With expanded functionality
- With special functions

SIRIUS safety relays

Standard devices

- Electronic enable circuits
 - 3TK2840-42 basic units
- Relay enable circuits
 - 3TK282. basic units
 - 3TK2830 expansion devices
- Contactor relay enable circuits
 - 3TK2850-53 basic units
 - 3TK2856/57 expansion devices
- Multi-function
 - 3TK2845

Special functions

- Movement monitoring
 - 3TK2810-0 standstill monitors
- Press control
 - 3TK2834 two-hand control device
 - 3TK2835 overtravel distance tester

Accessories

- Cover cap
- Fixing straps
- Screwdrivers

Further information

- Simulations
- Trailer
- Insertion plate

The optimum solution for every task: The range at a glance

Safety relays with basic functions

Safety relays with **electronic enable circuits**



Fast, safe and wear-free switching

Evaluation units with electronic components are clearly establishing themselves in safety-related applications. It's natural – the advantages are quite clear: Due to permanent function monitoring and wear-free operation, a significantly higher switching frequency and longer electrical lifetime are achieved. The compact and light devices also permit a series circuit to be configured and even operational switching – e.g. using a PLC. The devices can be supplemented by the 3TK2830 expansion units if several or electrically isolated enable circuits are required in your application.

Highlights:

- Permanent function monitoring
- No wear as they switch electronically
- High switching frequency
- Long electrical lifetime
- Electronic sensors can be evaluated
- Sensor cables up to max. 2000 m
- Cascading possible
- Insensitive to vibration and dirt
- Compact design, low weight
- Certified for the global market

Safety relays with **relay enable circuits**



Safety with electrically isolated contacts

SIRIUS safety relays with relay enable circuits are not just space-saving due to their compact design, but with pairs of positively driven NO contacts and feedback contacts offer a real plus when it comes to safety. This is how it works: If one of the contacts welds, then the other contact is used to shut down the circuit. A positively driven feedback signal contact (NC contact) detects the fault of the defective NO contact. Expansion units are available to increase the number of enable circuits. The 3TK2834 press control unit as safety-relevant evaluation unit is used for 2-hand operator consoles in press control systems.

Highlights:

- Compact design
- Electrically isolated safety outputs
- Also suitable for presses and punch controls
- Can be used up to an ambient temperature of max. 70 °C

Safety relays with
contactor relay enable circuits



The complete 3 in 1 device

We offer the perfect combination of electronic safety functionality and two redundant SIRIUS contactor relays with contacts. Pre-mounted, wired up, tested and certified as a unit. The only thing that you have to do is snap the complete devices onto the mounting rail. Simple, safe and quick.

Highlights:

- Electrically isolated enable circuits
- AC-15/DC-13 switching capacity
- Safe separation
- High mechanical and electrical endurance
- Certified as complete unit
- Faults are minimized and cost reduced as they are pre-wired in the factory
- Low mounting and installation costs

Safety relays with expanded functionality

3TK2845 multi-function device



Several safety functions combined in just one enclosure

Conventional safety applications – such as EMERGENCY STOP and protective door monitoring – could, up until now, only be implemented by using several individual safety relays. Our 3TK2845 multi-function devices now combine several functions in just one device. Two electronic and two relay enable circuits enable safety-relevant shutdown – with just few manual operations, fast and favorably priced.

Highlights:

- 2 sensor inputs (e.g. EMERGENCY STOP, protective door)
- Also suitable for protective door tumbler mechanisms (locks) and agreement button
- 2 electronic and 2 relay enable circuits

Safety relays with special functions

3TK2810-0 standstill monitor



Increased safety in hazardous areas

The standstill monitor detects motor standstills without the need for sensors via the residual magnetization of the rotating motor. Once an adjustable threshold value is fallen underrun, it enables access to the hazardous areas via its outputs, e.g. by unlocking a protective door.

Highlights:

- No additional sensors required
- Fault signaling via diagnostic display
- Settable standstill time
- Suitable for application with frequency converters

Description of the basic functions

SIRIUS safety relays and the safety chain

A safety chain generally comprises detecting, evaluating and shutting down functions.

This means in detail:

Detecting = identifying a safety-relevant request, e.g. if an EMERGENCY STOP button is pressed or a hazardous area, protected by sensors, light grids or laser scanners, is entered.

Evaluating = identifying a safety-relevant request and safely initiating the response, e.g. shutting down the enable circuits.

Shutting down = shutting down the potential danger, e.g. a power supply using the downstream contactor.

SIRIUS safety relays operate in the evaluating and responding area within this safety chain.

Functionality at a glance

Time is money. In order for you to quickly understand the specific functionality of the individual device types, we have illustrated the safety-related functions in a standard schematic layout. This is how it works: At a glance you can see the inputs in the sensor interface, the outputs and enable circuits in the actuator interface and the special safety logic.

In order to keep everything simple, the schematics only show the inputs and outputs that are required to explain the safety function. The power supply inputs and the sensors as well as actuators that can be connected to the interface have not been taken into account as they are not relevant for explaining the function.

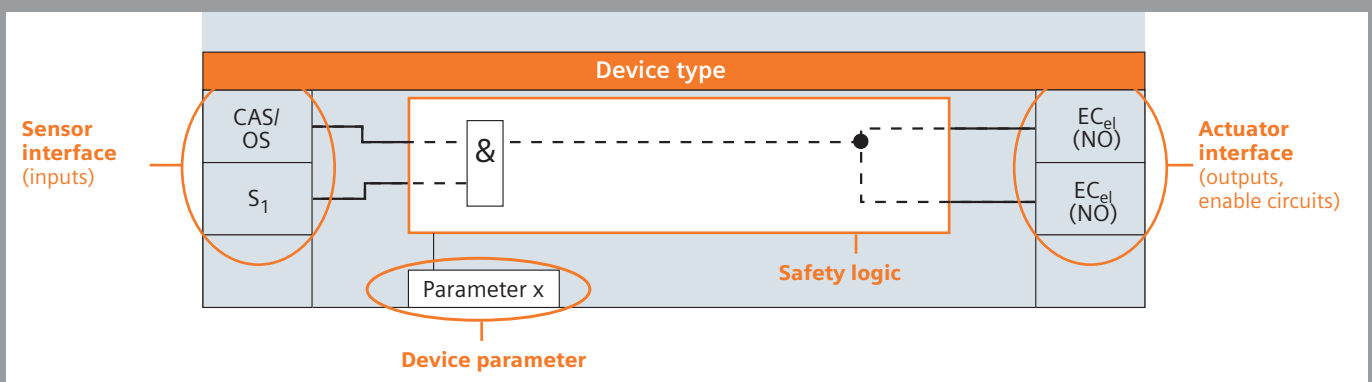
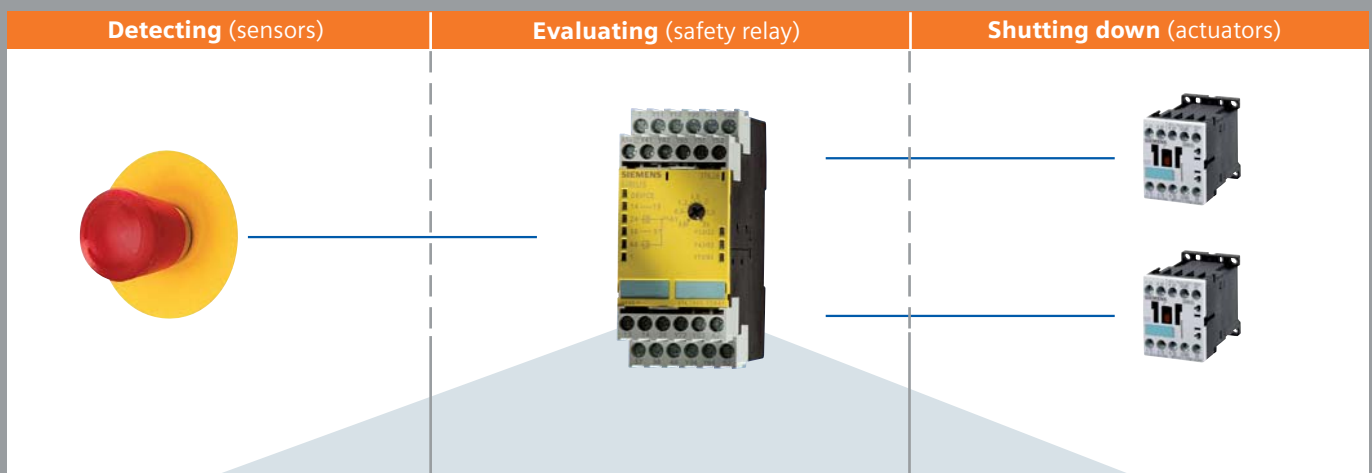

Legend

Sensor interface	
S_x	Sensor input
CAS/OS	Cascading input or operational switching (operational switching: Connected, e.g. to a PLC output. This means that the machine control can switch the enable circuits and therefore the connected loads. The safety-related function is a higher-level function)
A1	Power supply input as sensor input or cascading input (the cascading input: This is used to cascade/switch several safety relays with one another)
Key-operated switch	Bypasses the sensor connected to S2 (3TK2845) (standard/service operation)

Safety logic	
AS	Automatic start: The device automatically starts after the enable conditions are fulfilled. A manual start is also possible by incorporating a START button in the feedback circuit (up to Category 3 according to EN 954-1)
MS	Monitored start: The device only starts after the enable conditions have been fulfilled and a start signal has been issued
AS/MS	Automatic/monitored start – depending on what has been parameterized
	Time delay

Parameters	
AS/MS	Automatic/monitored start
1/2 channel	Single/two-channel sensor connection
CC	With/without cross-circuit fault monitoring

Actuator interface	
EC_{XX} (Y)	<p>XX= el: Enable circuit, electronic (not electrically isolated) rel: Enable circuit, relay contact (electrically isolated) cr: Enable circuit, contactor relay (electrically isolated) L1/L2/L3: Main current paths</p> <p>Y= NO: NO contact NO_{td}: NO contact, delayed</p>
SC_{XX} (Y)	<p>XX= el: Signaling circuit, electronic (not electrically isolated) rel: Signaling circuit, relay contact (electrically isolated) cr: Signaling circuit, contactor relay (electrically isolated)</p> <p>Y= NO: contact NC: contact</p>

3TK2840-42 electronic enable circuits

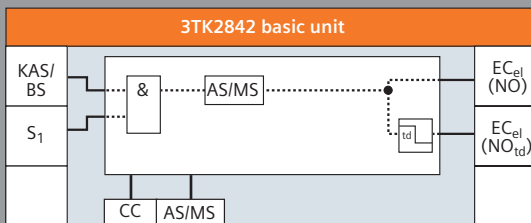
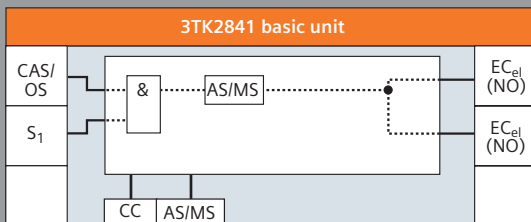
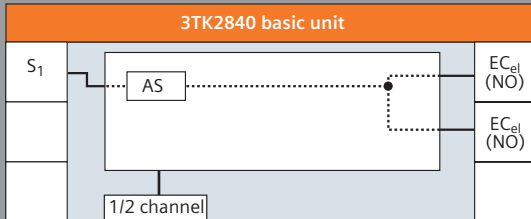

Type	Max. achievable Category acc. to EN 954-1	Max. achievable SIL acc. to IEC 61508	Rated control supply voltage (V)	Autostart/monitored start	Delay time (s)	Electronic sensors
3TK2840-□BB40	3	2	24 DC	AS	–	Yes
3TK2841-□BB40	4	3	24 DC	AS/MS	–	Yes
3TK2842-□BB41	4	3	24 DC	AS/MS	0.05...3	Yes
3TK2842-□BB42	4	3	24 DC	AS/MS	0.5...30	Yes
3TK2842-□BB44	4	3	24 DC	AS/MS	5...300	Yes

- 1** — Screw terminal
2 — Spring terminal



3TK2840

3TK282. relay enable circuits

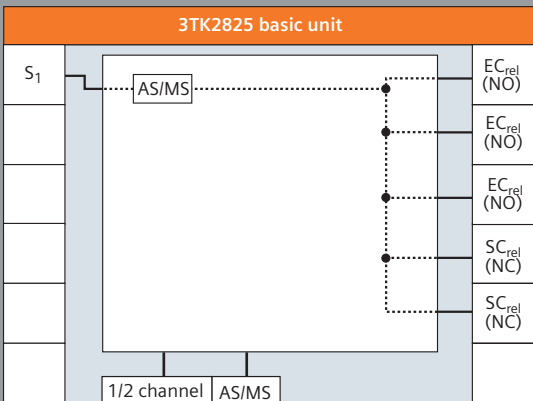
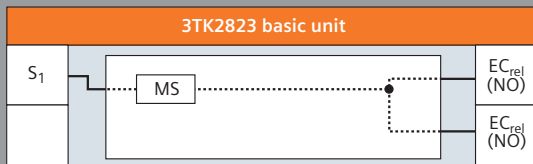
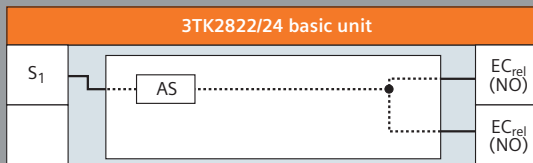
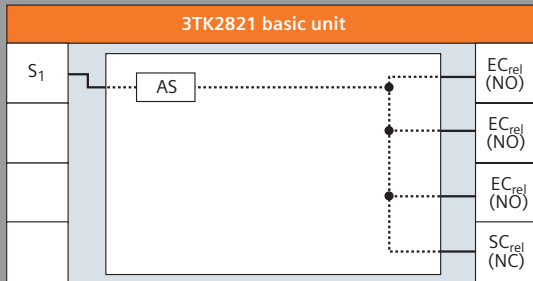

Type	Max. achievable Category acc. to EN 954-1	Max. achievable SIL acc. to IEC 61508	Rated control supply voltage (V)	Autostart/monitored start	Delay time (s)	Electronic sensors
3TK2821-□CB30	3	2	24 AC/DC	AS	–	–
3TK2822-□CB30	4	3	24 AC/DC	AS	–	–
3TK2823-□CB30	4	3	24 AC/DC	MS	–	–
3TK2824-□CB30	3	2	24 AC/DC	AS	–	–
3TK2824-□BB40	3	2	24 DC	AS	–	–
3TK2824-□AJ20	3	2	115 AC	AS	–	–
3TK2824-□AL20	3	2	230 AC	AS	–	–
3TK2825-□BB40	4	3	24 DC	AS/MS	–	–
3TK2825-□AB20	4	3	24 AC	AS/MS	–	–
3TK2825-□AJ20	4	3	115 AC	AS/MS	–	–
3TK2825-□AL20	4	3	230 AC	AS/MS	–	–
3TK2826-□BB40	4	3	24 DC	AS/MS	–	yes
3TK2826-□CW30	4	3	24 ...240 AC/DC	AS/MS	–	yes
3TK2826-□BB41	4	3	24 DC	AS/MS	0.05 ...3	yes
3TK2826-□CW31	4	3	24 ...240 AC/DC	AS/MS	0.05 ...3	yes
3TK2826-□BB42	4	3	24 DC	AS/MS	0.5 ...30	yes
3TK2826-□CW32	4	3	24 ...240 AC/DC	AS/MS	0.5 ...30	yes
3TK2826-□BB44	4	3	24 DC	AS/MS	5 ...300	yes
3TK2826-□CW34	4	3	24 ...240 AC/DC	AS/MS	5 ...300	yes

- 1 — Screw terminal
2 — Spring terminal



3TK2821



3TK2826



3TK2826
with opened front cover

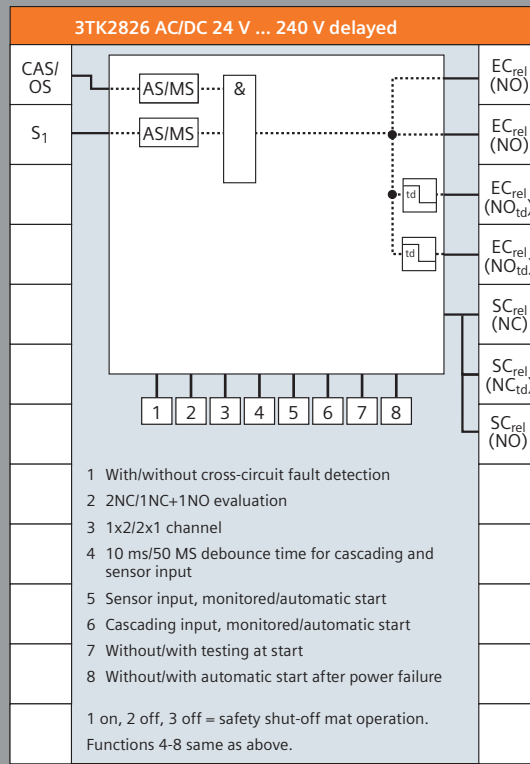
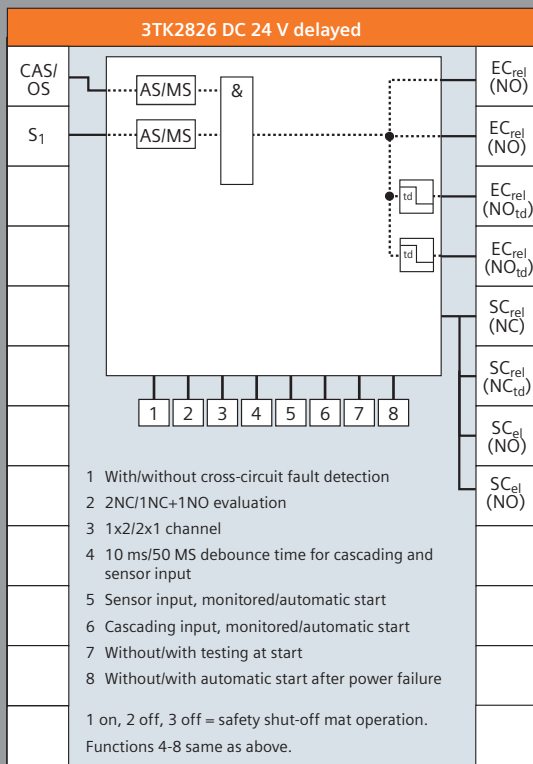
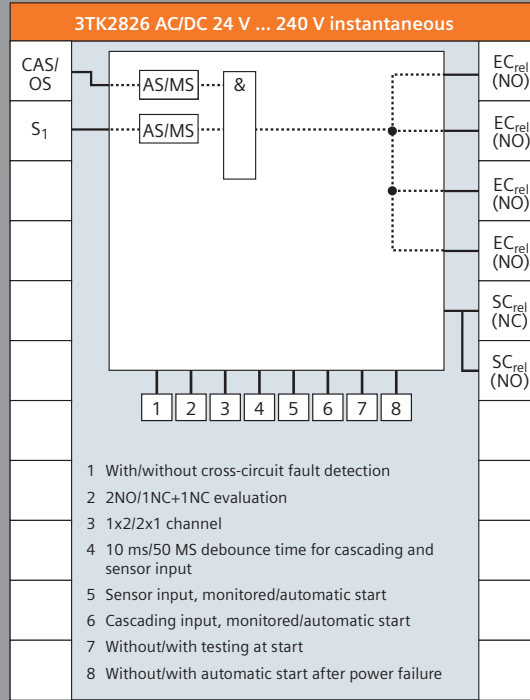
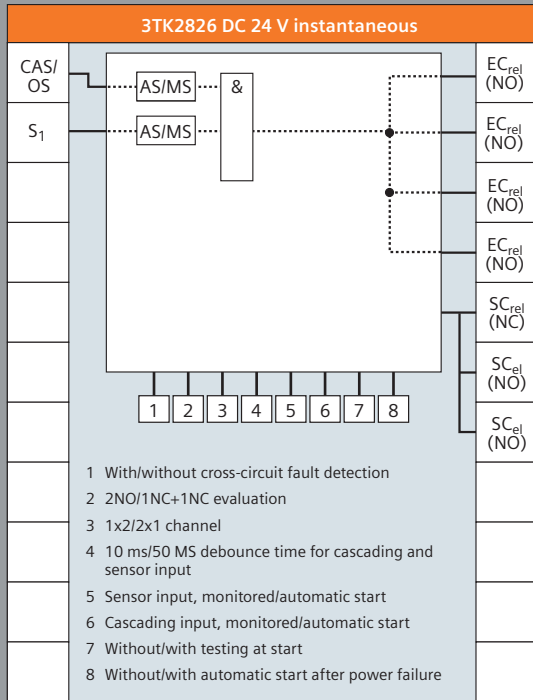

Detailed information on the functional principle and parameterization options of the 3TK2826 safety relays is provided by the online simulation at www.siemens.com/safety-relays.

3TK282. / 3TK283. relay enable circuits

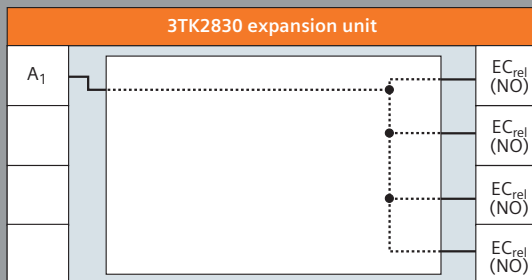
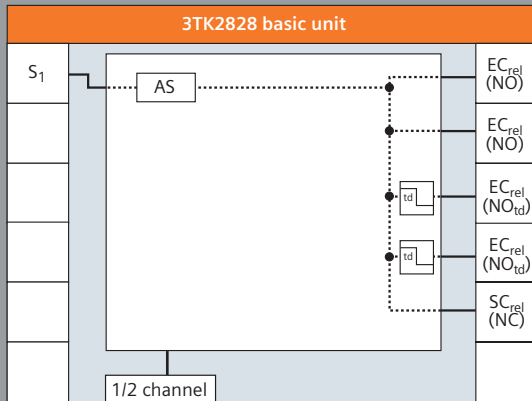
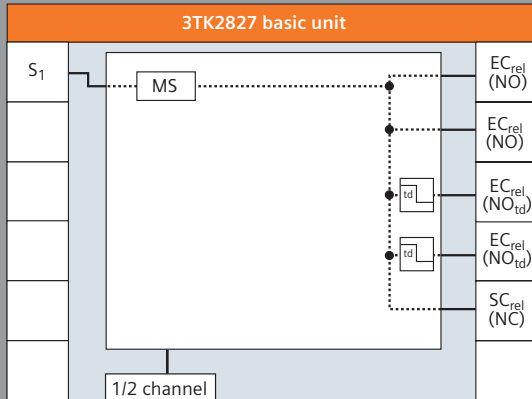

Type	Max. achievable Category acc. to EN 954-1 instantaneous/delayed	Max. achievable SIL acc. to IEC 61508	Rated control supply voltage (V)	Autostart/monitored start	Delay time (s)	Electronic sensors
3TK2827-□BB40	4/3	–	24 DC	MS	0.5...30	–
3TK2827-□AB20	4/3	–	24 AC	MS	0.5...30	–
3TK2827-□AJ20	4/3	–	115 AC	MS	0.5...30	–
3TK2827-□AL20	4/3	–	230 AC	MS	0.5...30	–
3TK2827-□BB41	4/3	–	24 DC	MS	0.05...3	–
3TK2827-□AB21	4/3	–	24 AC	MS	0.05...3	–
3TK2827-□AJ21	4/3	–	115 AC	MS	0.05...3	–
3TK2827-□AL21	4/3	–	230 AC	MS	0.05...3	–
3TK2828-□BB40	4/3	–	24 DC	AS	0.5...30	–
3TK2828-□AB20	4/3	–	24 AC	AS	0.5...30	–
3TK2828-□AJ20	4/3	–	115 AC	AS	0.5...30	–
3TK2828-□AL20	4/3	–	230 AC	AS	0.5...30	–
3TK2828-□BB41	4/3	–	24 DC	AS	0.05...3	–
3TK2828-□AB21	4/3	–	24 AC	AS	0.05...3	–
3TK2828-□AJ21	4/3	–	115 AC	AS	0.05...3	–
3TK2828-□AL21	4/3	–	230 AC	AS	0.05...3	–
3TK2830-□CB30	as for the basic unit	–	24 AC/DC	–	–	–
3TK2830-□AJ20	as for the basic unit	–	115 AC	–	–	–
3TK2830-□AL20	as for the basic unit	–	230 AC	–	–	–

Press control units

3TK2834-□BB40	4/–	–	24 DC	–	–	–
3TK2834-□AB20	4/–	–	24 AC	–	–	–
3TK2834-□AJ20	4/–	–	115 AC	–	–	–
3TK2834-□AL20	4/–	–	230 AC	–	–	–
3TK2835-□BB40	–	–	24 DC	–	–	–
3TK2835-□AB20	–	–	24 AC	–	–	–
3TK2835-□AJ20	–	–	115 AC	–	–	–
3TK2835-□AL20	–	–	230 AC	–	–	–

- 1 — Screw terminal
2 — Spring terminal



3TK2827



3TK2830

3TK285. contactor relay enable circuits/basic units

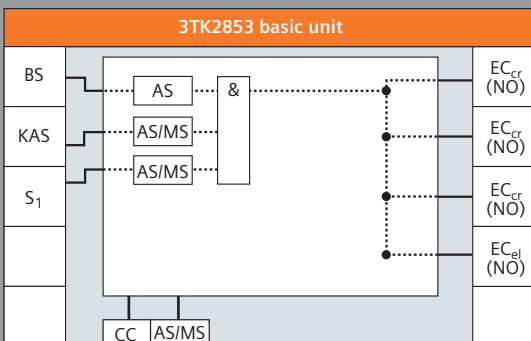
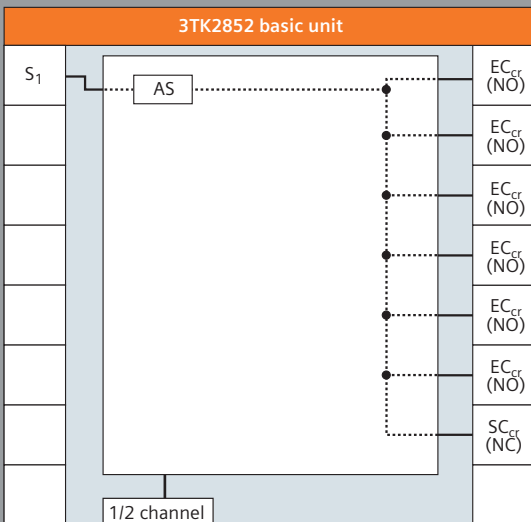
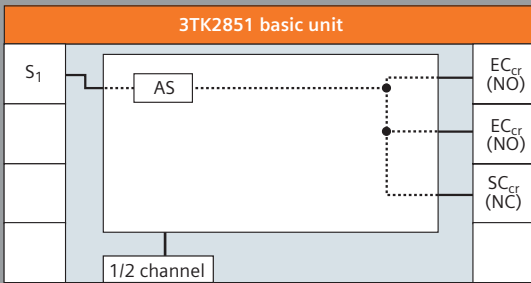
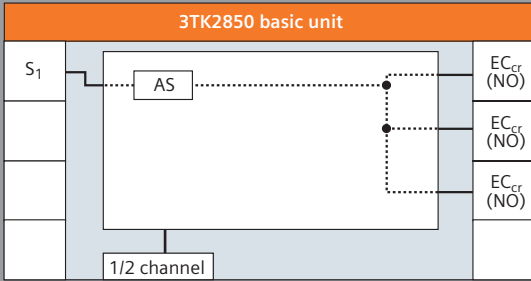

Type	Max. achievable Category acc. to EN 954-1	Max. achievable SIL acc. to IEC 61508	Rated control supply voltage (V)	Autostart/monitored start	Delay time (s)	Electronic sensors
3TK2850-□BB40	3	2	24 DC	AS/MS	–	Yes
3TK2850-□AJ20	3	2	115 AC	AS/MS	–	Yes
3TK2850-□AL20	3	2	230 AC	AS/MS	–	Yes
3TK2851-□BB40	3	2	24 DC	AS/MS	–	Yes
3TK2851-□AJ20	3	2	115 AC	AS/MS	–	Yes
3TK2851-□AL20	3	2	230 AC	AS/MS	–	Yes
3TK2852-□BB40	3	2	24 DC	AS/MS	–	Yes
3TK2852-□AL20	3	2	230 AC	AS/MS	–	Yes
3TK2853-□BB40	4	3	24 DC	AS/MS	–	Yes

- 1** — Screw terminal
2 — Spring terminal



3TK2850

3TK285. contactor relay enable circuits/expansion units

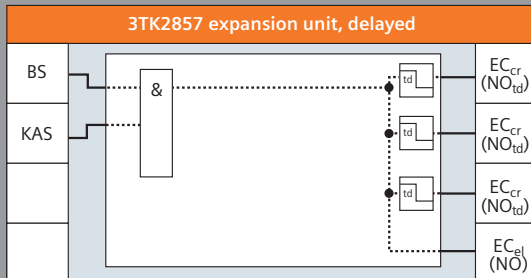
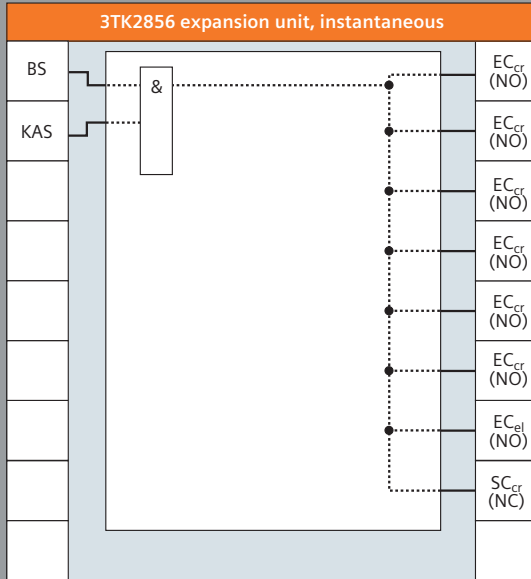

Type	Max. achievable Category acc. to EN 954-1	Max. achievable SIL acc. to IEC 61508	Rated control supply voltage (V)	Autostart/monitored start	Delay time (s)
3TK2856-□BB40	as for the basic unit	3	24 DC	–	–
3TK2857-□BB41	as for the basic unit	3	24 DC	–	0.05...3
3TK2857-□BB42	as for the basic unit	3	24 DC	–	0.5...30
3TK2857-□BB44	as for the basic unit	3	24 DC	–	5...300

- 1** — Screw terminal
2 — Spring terminal

Function description for expanded functions

3TK2845 multi-function device

Type	Max. achievable Category acc. to EN 954-1	Max. achievable SIL acc. to IEC 61508	Rated control supply voltage (V)	Autostart / monitored start	Delay time (s)	Electronic sensors
3TK2845- <input type="checkbox"/> HB40	4	3	24 DC	AS/MS	–	yes
3TK2845- <input type="checkbox"/> HB41	4	3	24 DC	AS/MS	0.05...3	yes
3TK2845- <input type="checkbox"/> HB42	4	3	24 DC	AS/MS	0.5...30	yes
3TK2845- <input type="checkbox"/> HB44	4	3	24 DC	AS/MS	5...300	yes
3TK2845- <input type="checkbox"/> DB40	4	3	24 DC	MS	–	yes
3TK2845- <input type="checkbox"/> DB41	4	3	24 DC	MS	0.05...3	yes
3TK2845- <input type="checkbox"/> DB42	4	3	24 DC	MS	0.5...30	yes
3TK2845- <input type="checkbox"/> DB44	4	3	24 DC	MS	5...300	yes
3TK2845- <input type="checkbox"/> EB40	4	3	24 DC	AS/MS	–	yes
3TK2845- <input type="checkbox"/> EB41	4	3	24 DC	AS/MS	0.05...3	yes
3TK2845- <input type="checkbox"/> EB42	4	3	24 DC	AS/MS	0.5...30	yes
3TK2845- <input type="checkbox"/> EB44	4	3	24 DC	AS/MS	5...300	yes
3TK2845- <input type="checkbox"/> FB41	4	3	24 DC	MS	0.05...3	yes
3TK2845- <input type="checkbox"/> FB42	4	3	24 DC	MS	0.5...30	yes
3TK2845- <input type="checkbox"/> FB44	4	3	24 DC	MS	5...300	yes
3TK2845- <input type="checkbox"/> GB41	4	3	24 DC	MS	0.05...3	yes
3TK2845- <input type="checkbox"/> GB42	4	3	24 DC	MS	0.5...30	yes
3TK2845- <input type="checkbox"/> GB44	4	3	24 DC	MS	5...300	yes

- Screw terminal
 — Spring terminal

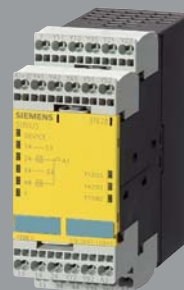

3TK2845



3TK2845 (delayed)

3TK2845-.HB4. multi-function device "monitored and automatic start"

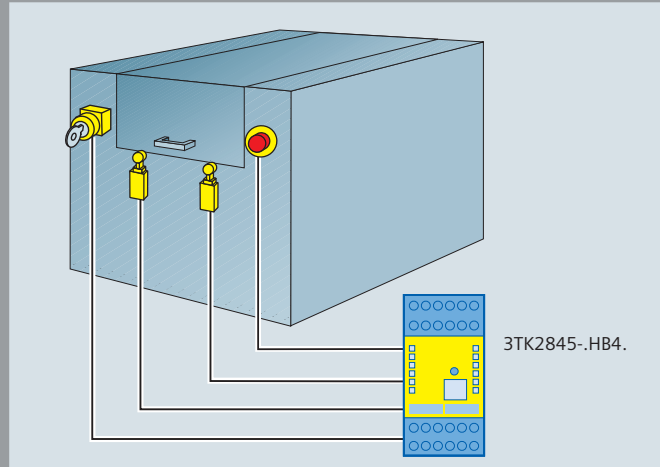
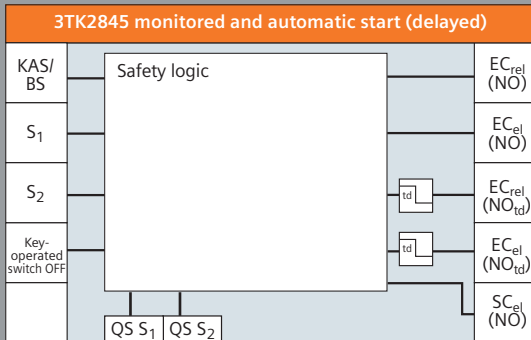
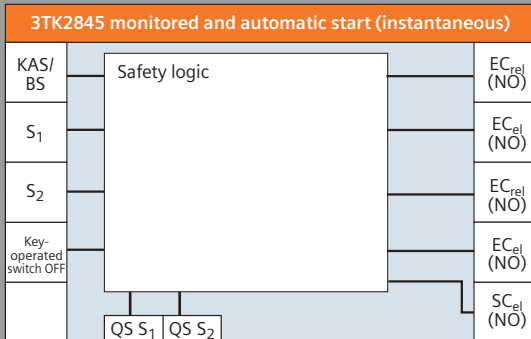

Example 3TK2845-.HB4.
Processing station with protective hood and EMERGENCY STOP

3TK2845-.DB4. multi-function device "monitored start"

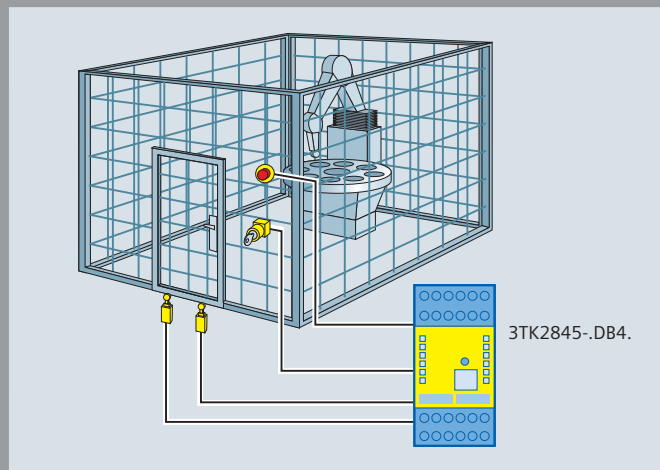
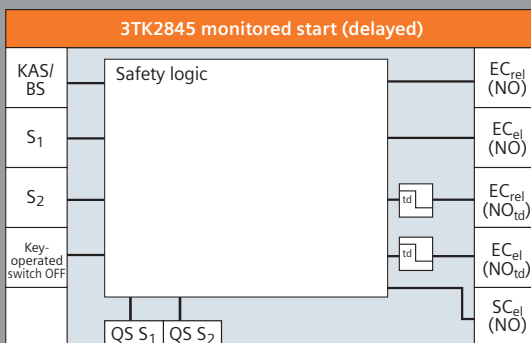
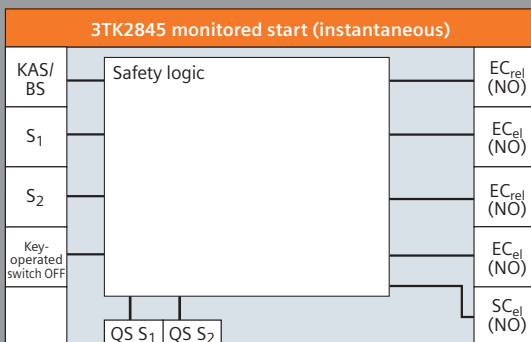

Example 3TK2845-.DB4.
Robot cell with protective door and EMERGENCY STOP

If required, these devices can be switched over from normal to service operation via a switch.

Detailed information on the functional principle and parameterization options of the 3TK2826 safety relays is provided by the online simulation at www.siemens.com/safety-relays.

3TK2845-.EB4. multi-function device "agreement button"

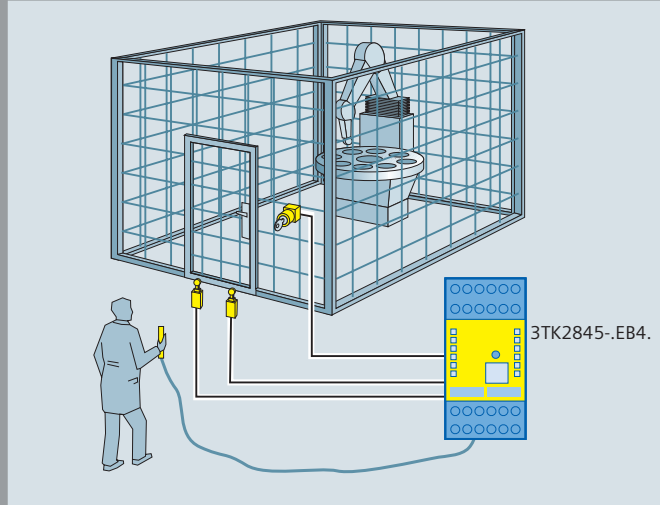
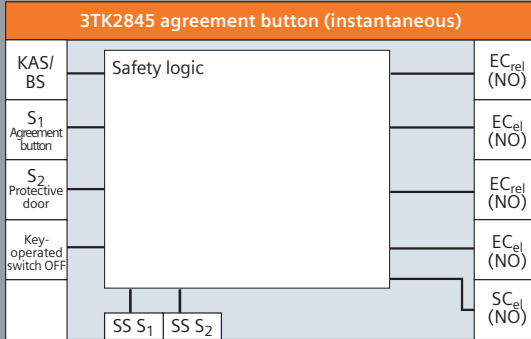

Example 3TK2845-.EB4.
Robot cell with protective door and agreement button

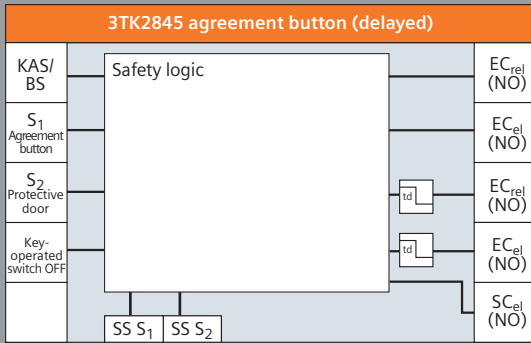

3TK2845-.FB4./GB4. multi-function device "protective door tumbler mechanism spring force/magnetic force interlocked"

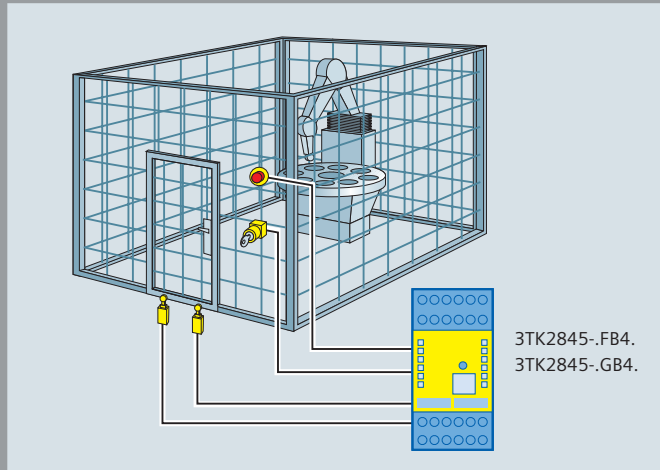
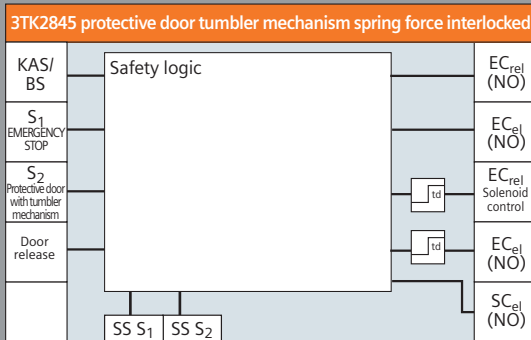

Example 3TK2845-.FB4. /GB4.
Robot cell with protective door with tumbler mechanism and EMERGENCY STOP

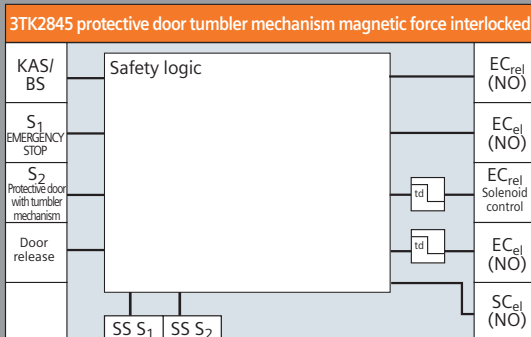

standstill monitor 3TK2810.

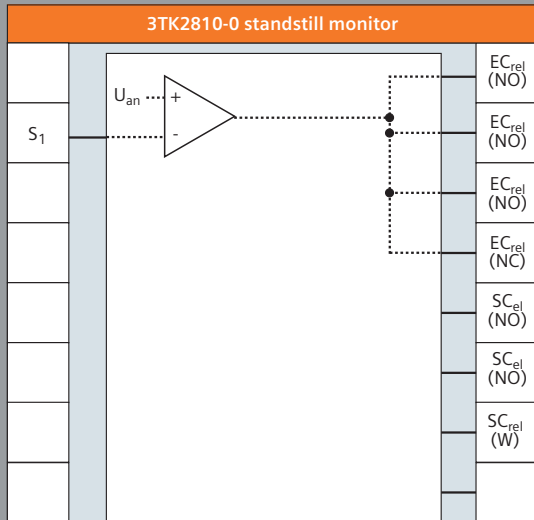

Type	Max. achievable Category acc. to EN 954-1	Max. achievable SIL acc. to IEC 61508	Rated control supply voltage (V)	Automatic/monitored start	Delay time (s)	Electronic sensors
3TK2810-0BA0.	4	3	24 DC	–	0.2 ...6	–
3TK2810-0GA0.	4	3	230 AC	–	0.2 ...6	–
3TK2810-0JA0.	4	3	400 AC	–	0.2 ...6	–



3TK2810

Ordering by fax +49/911/978-3321 CD/Z1218



SIRIUS Industrial Controls

Newsletter

Always up-to-date: Our regular Newsletter gives you current information about industrial controls and power distribution. Simply register under www.siemens.com/lowvoltage/newsletter

Please send the selected information to the following address:

Company/Department

Name

Street, Postal Code/City

Telephone/Fax

E-mail

SWITCHING

SIRIUS Solid-state switching devices

STARTING

SIRIUS Infeed system

SIRIUS Engineering load feeders

SIRIUS Soft starter

SIMATIC ET 200pro

SIRIUS Motor starter

MONITORING AND CONTROLLING

SIRIUS Motor management system SIMOCODE pro

SIRIUS Relays

SIRIUS Safety Relays

DETECTING

SIRIUS Position switches

COMMANDING AND SIGNALING

SIRIUS Pushbuttons and indicator lights

SIRIUS Signaling columns and integrated signal lamps

SIRIUS Cable-operated switches

SUPPLYING

SIVENT Fans

SIDAC Reactors & filters

SIDAC & SIVENT Solutions

ENGINEERING

Motor starter ES

SIMOCODE ES

Soft starter ES

SIRIUS AND MORE

SIRIUS Safety Integrated

AS-Interface

SIRIUS Connection systems

ECOFAST

AS-i News

SIRIUS Modular system

Siemens AG

Automation and Drives
Low-Voltage Controls and Distribution
P.O. Box 48 48, 90327 NUREMBERG, GERMANY

www.siemens.com/lowvoltage/technical-assistance
www.siemens.com/sirius

The information provided in this brochure contains merely general descriptions or characteristics of performance which in case of actual use do not always apply as described or which may change as a result of further development of the products. An obligation to provide the respective characteristics shall only exist if expressly agreed in the terms of contract.

All product designations may be trademarks or product names of Siemens AG or supplier companies whose use by third parties for their own purposes could violate the rights of the owners.